

# HANDY by bürotime

technical document



# HANDY



“Pedagogical approaches that change along with technology accelerates the alteration towards student-oriented, active learning environments while creating opportunities for new learning methods. As Burotime, inspired by active learning approaches that do not limit education to defined spaces, we offer effective solutions that will convert every corner of the educational institution into a learning space.”



Handy offers functional solutions to the learning-oriented education areas at appropriate sizes for different age groups. Fixed and mobile leg options allow to create dynamic spaces that can be adaptable to various learning methods. With its melamine and compact laminate table options, it is also suitable for social areas such as cafeteria, canteen, foyer and lobby.





Handy product family supports individual works with instructor and working desk versions, meanwhile encourages team spirit by strengthening communication with its hexagonal, trapezoidal, square and rectangular forms.



# product family \_\_\_\_\_

instructor desk



desk



tables



hexagon

trapezoid

square

rectangle

mobile tables



hexagon

trapezoid

square

rectangle

# table sizes

---

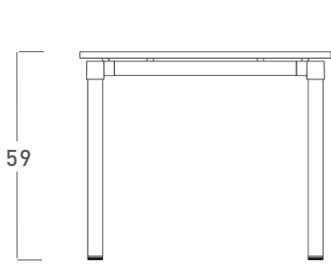
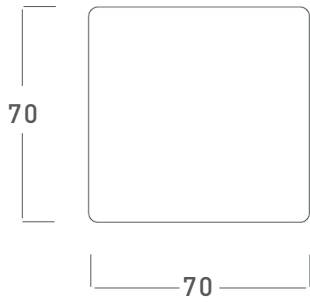
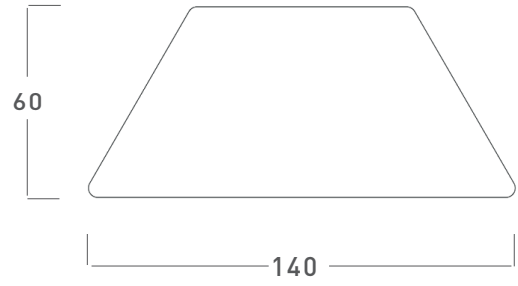
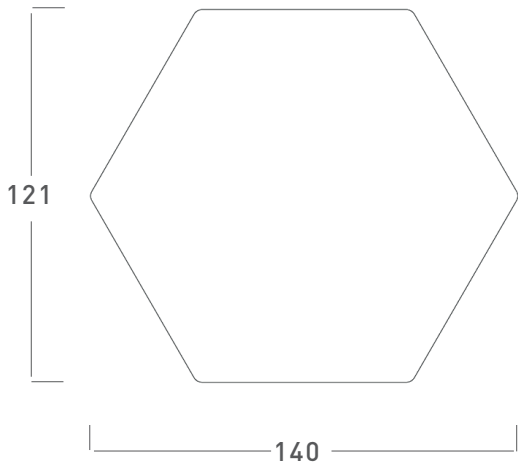

small

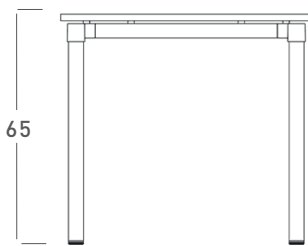

medium

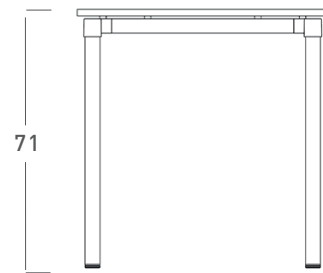

large

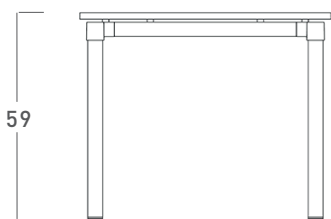

small

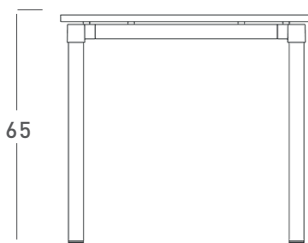

medium

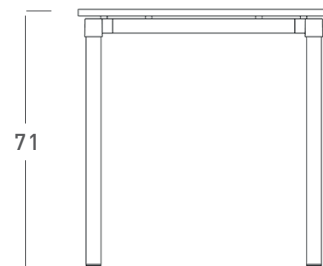

large

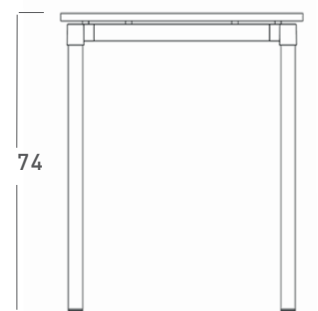

xlarge

# desk sizes

---

instructor desks

desks

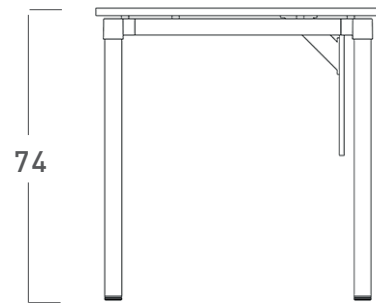
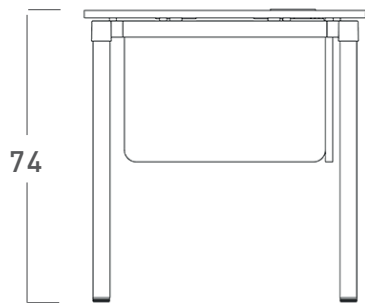
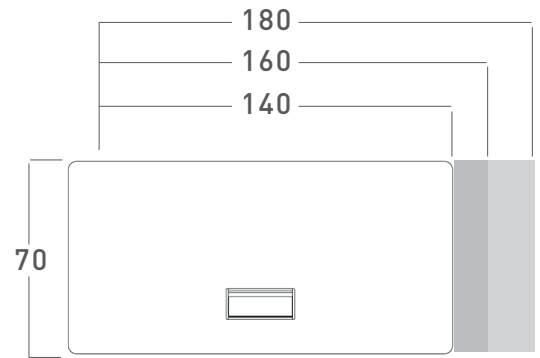
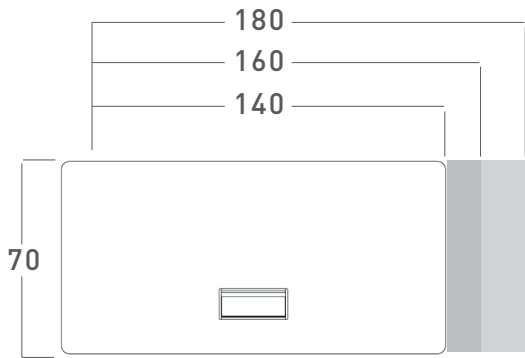

\*table grommet is optional

\*table grommet and modesty panel are optional

# table top options

---

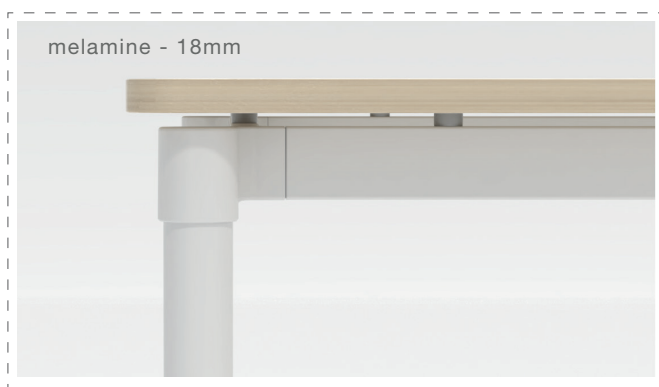

# table leg options

---

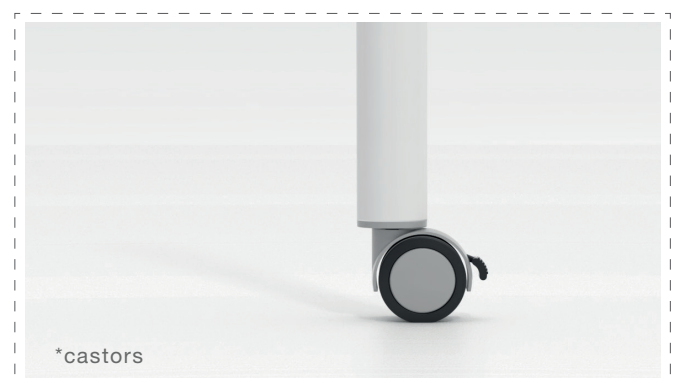
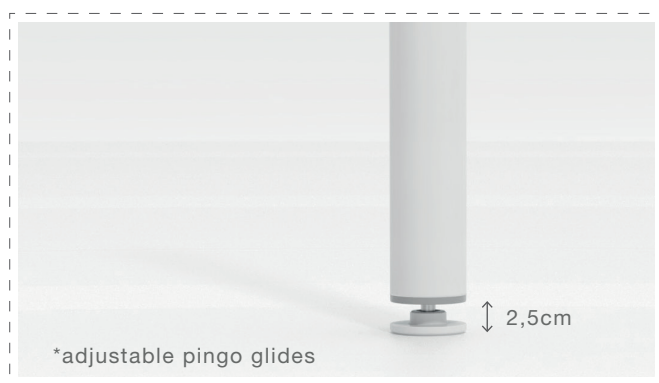



## color options

---

### melamine

---

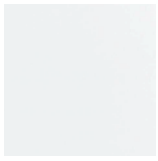

white



grey

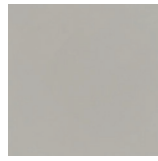

sand



antrachite



samba walnut



oleaster



ash oak



hazelnut

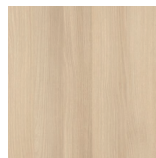

acacia

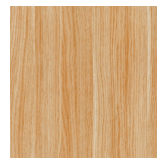

natural oak



african oak

### metal

---

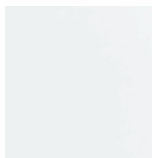

white

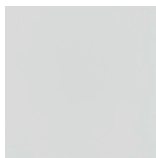

grey

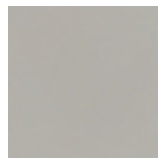

sand

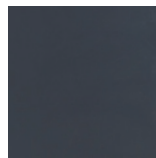

antrachite



black



